

Aşağıda verilen sayıların çevrimlerini yapınız

1-1 $(1011)_2 = (?)_{10} \rightarrow (11)_{10}$

1-2 $(11)_2 = (?)_{10} \rightarrow (3)_{10}$

1-3 $(101)_2 = (?)_{10} \rightarrow (5)_{10}$

1-4 $(111)_2 = (?)_{10} \rightarrow (7)_{10}$

1-5 $(11011100)_2 = (?)_{10} \rightarrow (220)_{10}$

1-6 $(125)_{10} = (?)_2 \rightarrow (1111101)_2$

1-7 $(7,8125)_{10} = (?)_2 \rightarrow (111,1101)_2$

1-8 $(47)_8 = (?)_{10} \rightarrow (39)_{10}$

1-9 $(566)_8 = (?)_{10} \rightarrow (374)_{10}$

1-10 $(33)_{10} = (?)_8 \rightarrow (41)_8$

1-11 $(45)_{16} = (69)_{10}$

1-12 $(63.25)_{dec} = (?)_{bin}$

- a) 111111.11 b) 111001.01 c) 111111.01 d) 111111.1 e) Hiçbiri

1-13 $(43.8125)_{dec} = (?)_{bin}$

- a) 101011.1101 b) 110101.1101 c) 101011.1011 d) 110101.1011 e) Hiçbiri

1-14 $(1001011.011)_{bin} = (?)_{dec}$

- a) 73.0375 b) 75.375 c) 91.375 d) 75.573 e) Hiçbiri

1-15 $(110101.1011)_{bin} = (?)_{dec}$

- a) 53.6875 b) 53.6375 c) 52.6875 d) 55.6375 e) Hiçbiri

1-16 $(11001.1)_{bin} = (?)_{oct}$

- a) 62.4 b) 62.1 c) 31.1 d) 31.2 e) 31.4

1-17 $(25.6)_{oct} = (?)_{bin}$

- a) 10101.11 b) 11101.10 c) 10101.10 d) 10010.11 e) 11111.01

1-18 $(35.1)_{oct} = (?)_{hex}$

- a) 17.4 b) 1D.1 c) D1.2 d) E8.1 e) Hiçbiri

1-19 $(39.A)_{hex} = (?)_{oct}$

- a) 35.5 b) 70.5 c) 71.5 d) 72.25 e) 75.5

1-20 $(485)_{dec} = (?)_{hex}$

- a) 1E5 b) 231 c) 5E1 d) 15E e) Hiçbiri

Aşağıda verilen lojik ifadeleri sadeleştiriniz

$$2-1 Q = A' B' C' + A B' C' + B C + A' B' C + A B' C = \dots\dots\dots = C + B'$$

$$2-2 F = A C + A' C + C' = \dots\dots\dots = 1$$

$$2-3 Q = (A' B' C')' = \dots\dots\dots = A + B + C$$

$$2-4 D = A C + B (A' C + A) = \dots\dots\dots = A C + A B + B C$$

$$2-5 S = B' C' A' + A' B C + A B' C' + B' C A = \dots\dots\dots = B' C' + A B' + A' B C$$

Aşağıda verilen lojik ifadeyi sadeleştirerek doğruluğunu doğruluk tablosunda karşılaştırınız

$$2-6 [A' B' + (A + B')]' = \dots\dots\dots = A$$

Aşağıdaki lojik devrelerin çıkışlarındaki lojik ifadeyi bularak varsa gerekli sadeleştirmeleri yapınız.

Örnek 3-1

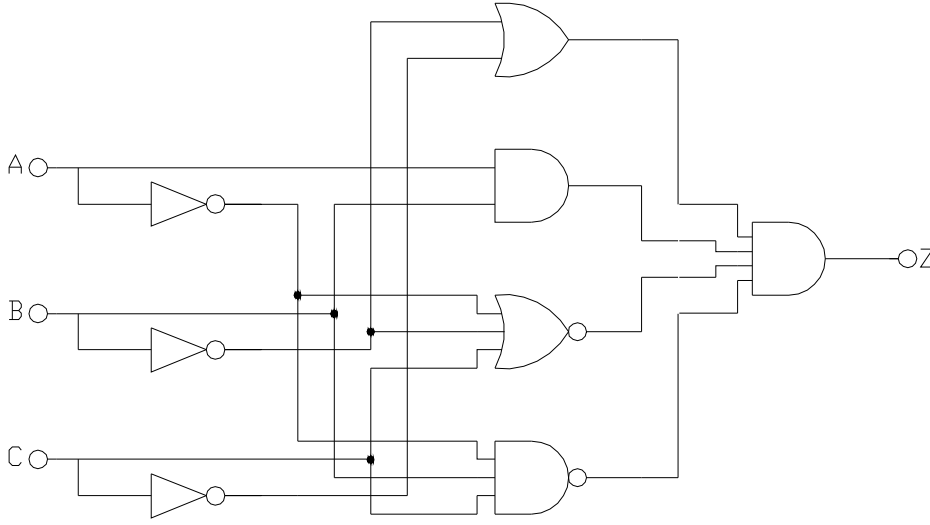

Örnek 3-2

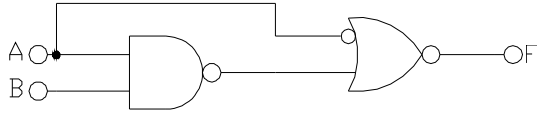

Örnek 3-3

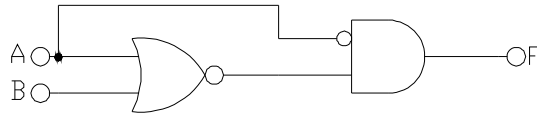

Örnek 3-4

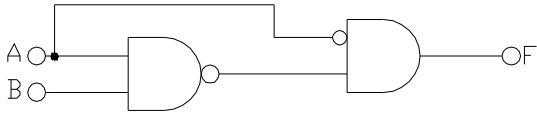

Örnek 3-5

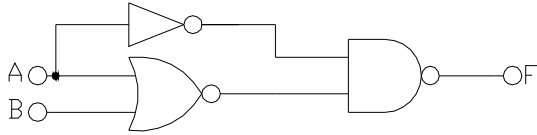

Örnek 3-6

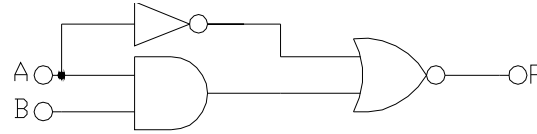

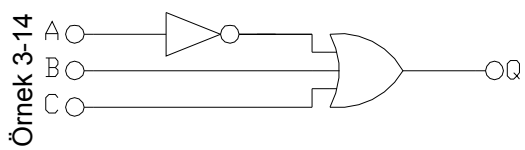
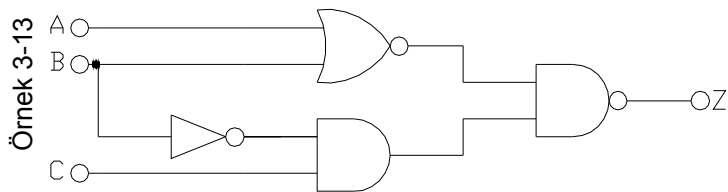
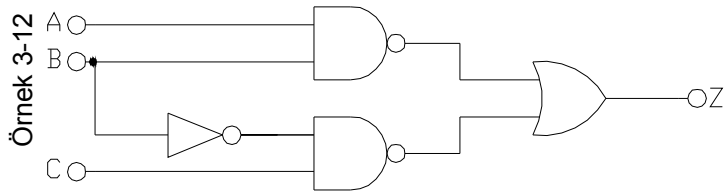
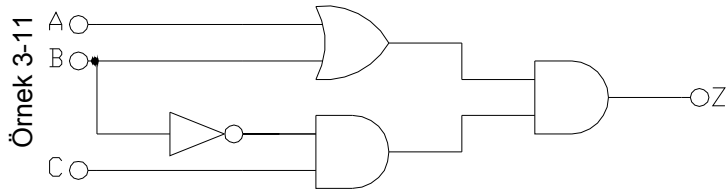
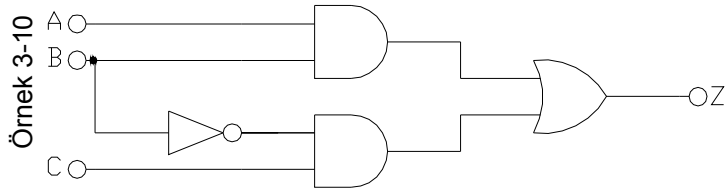
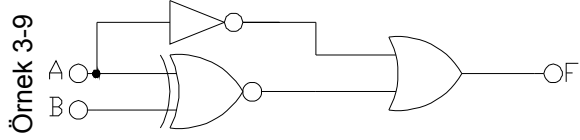
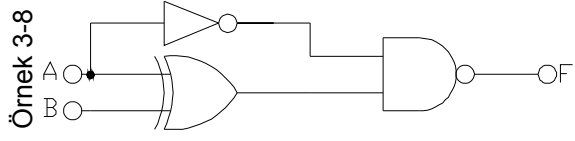
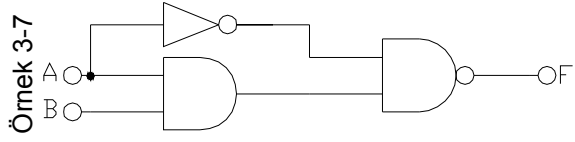

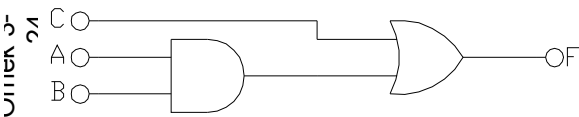
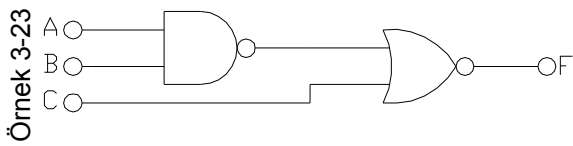
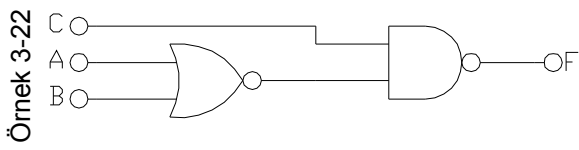
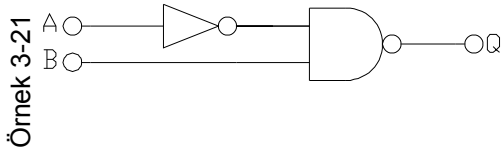
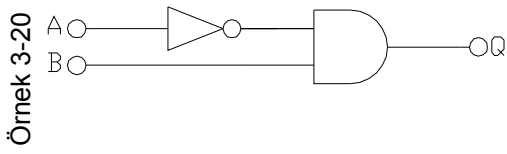
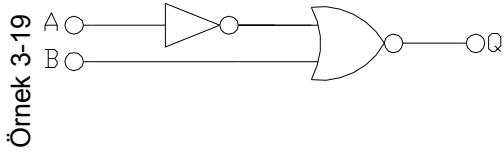
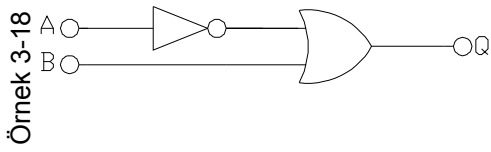
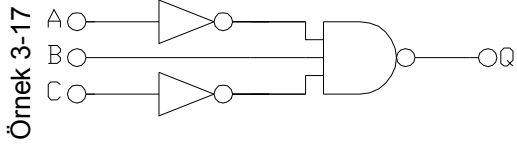
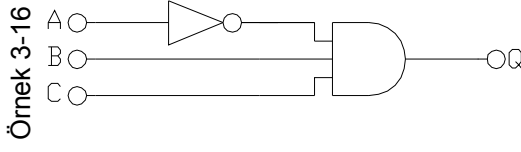
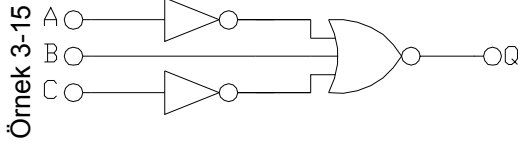

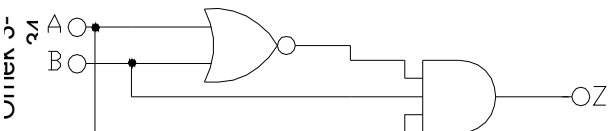
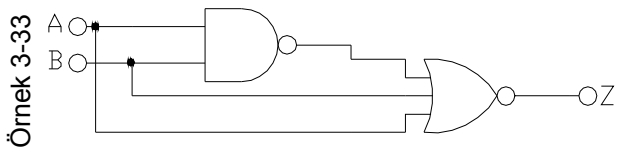
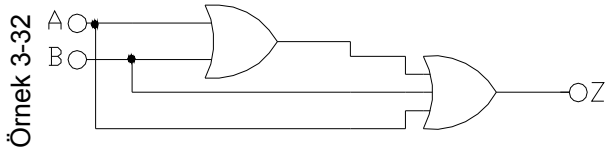
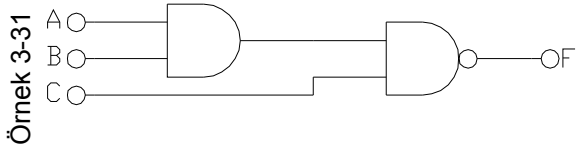
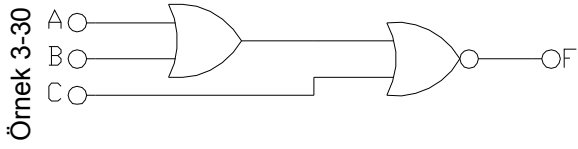
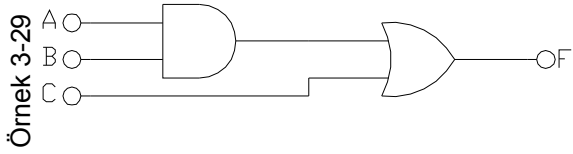
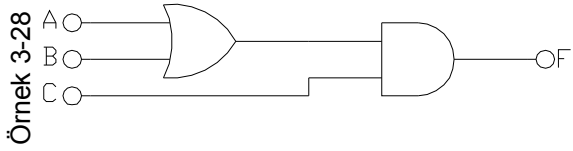
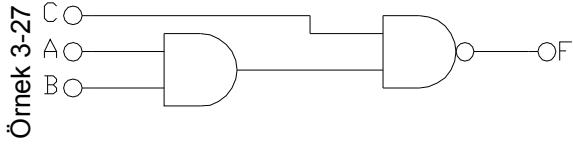
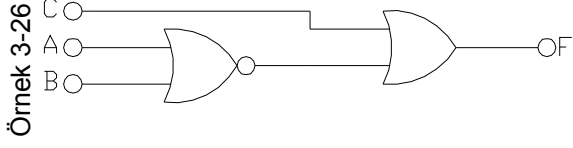
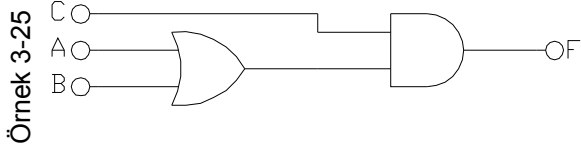

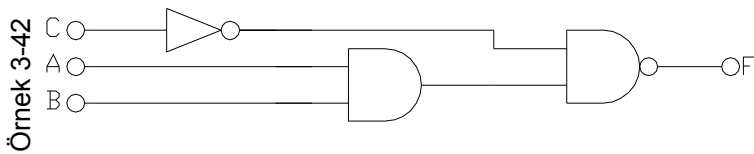
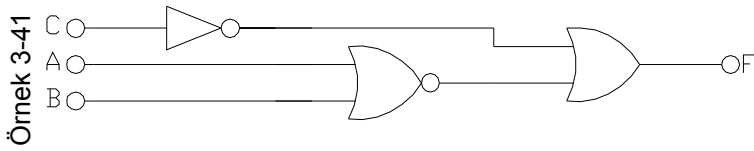
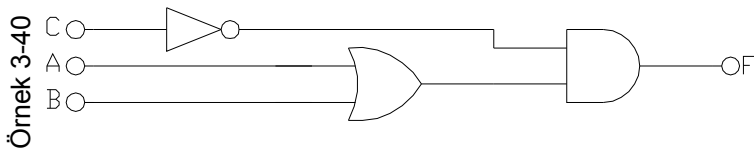
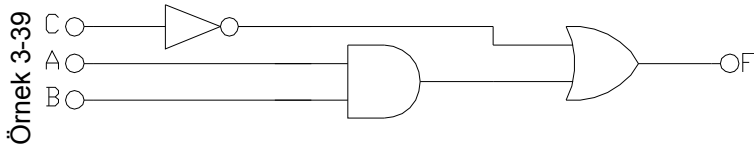
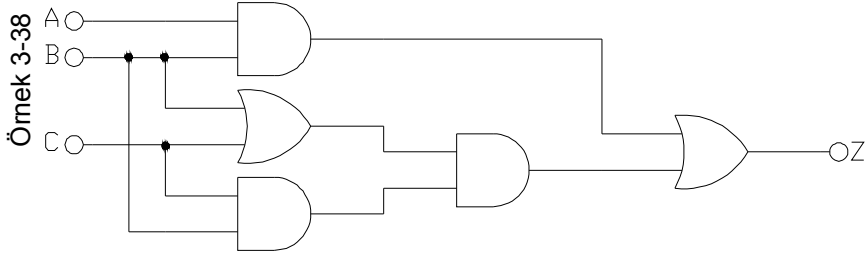
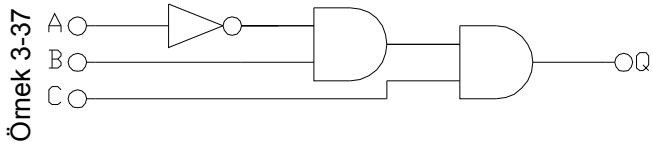
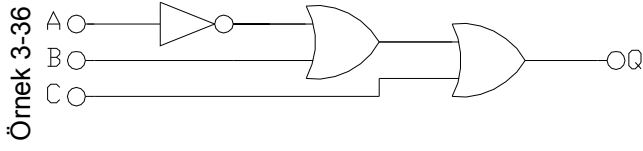
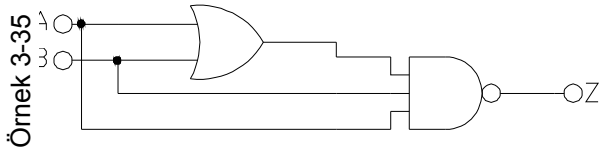

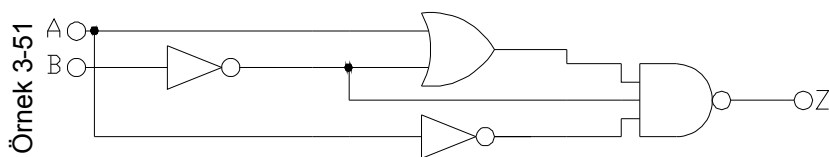
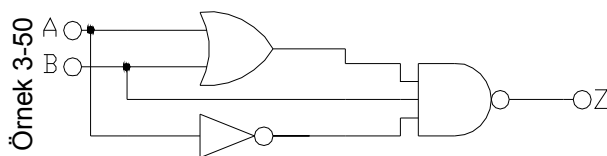
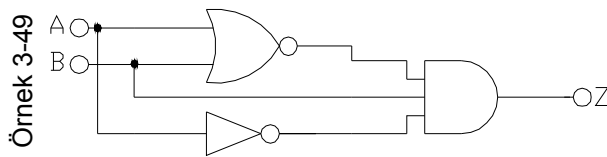
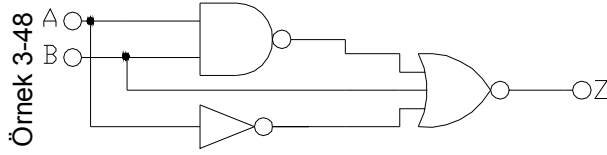
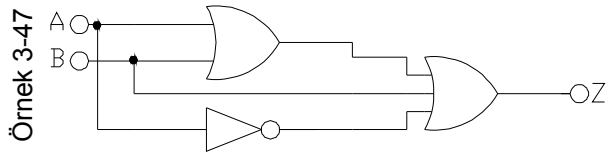
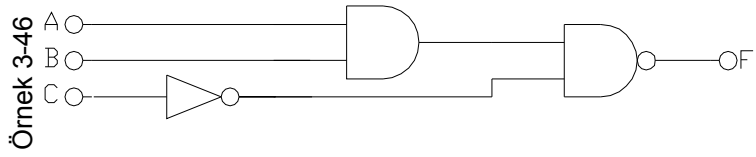
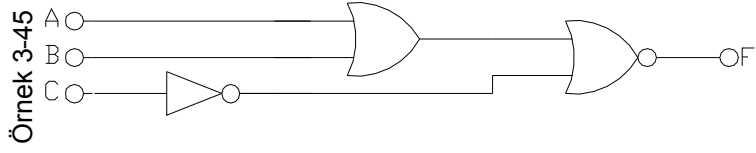
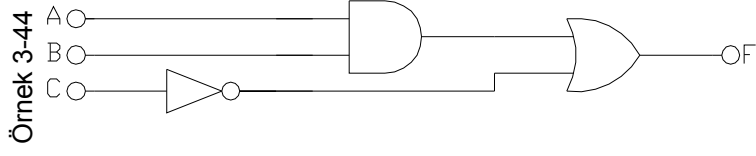
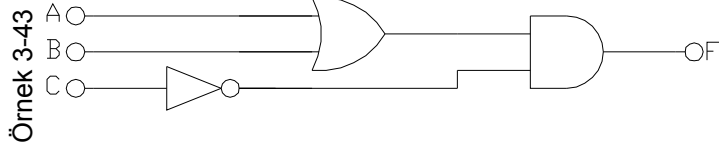

Örnek 3-52

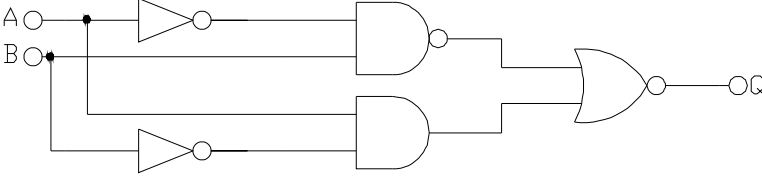

Örnek 3-53

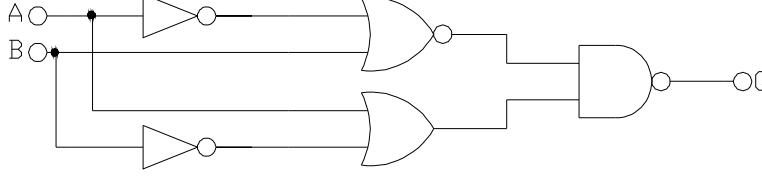

Örnek 3-54

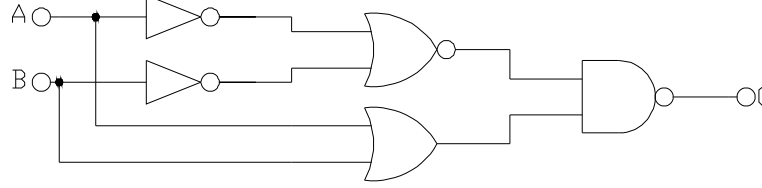

Örnek 3-55

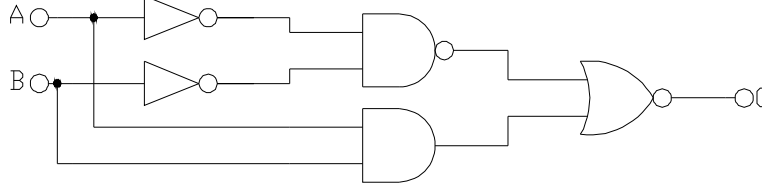

Örnek 3-56

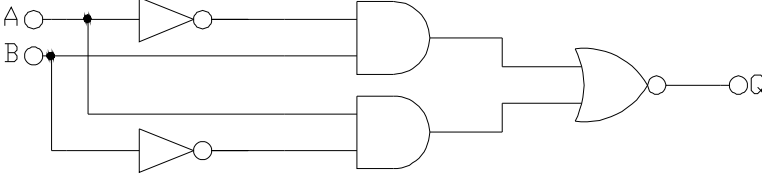

Örnek 3-57

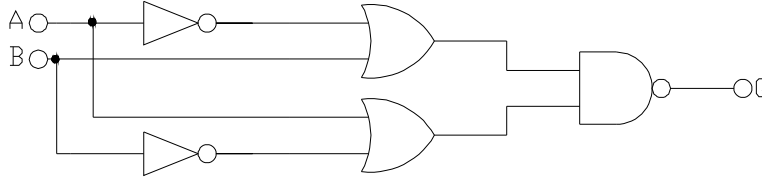

Örnek 3-58

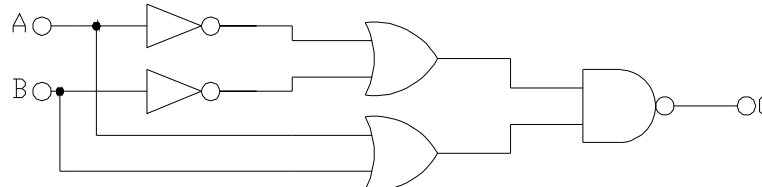

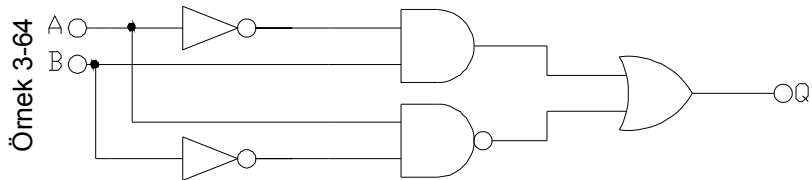
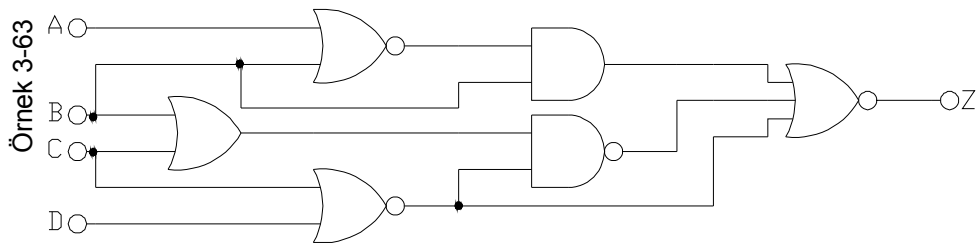
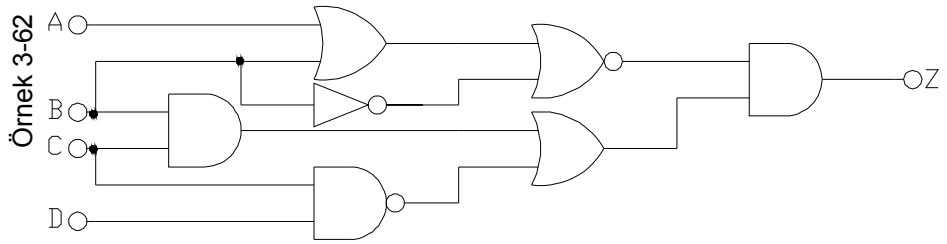
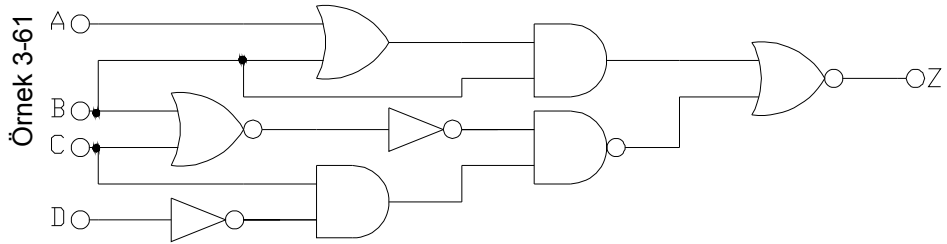
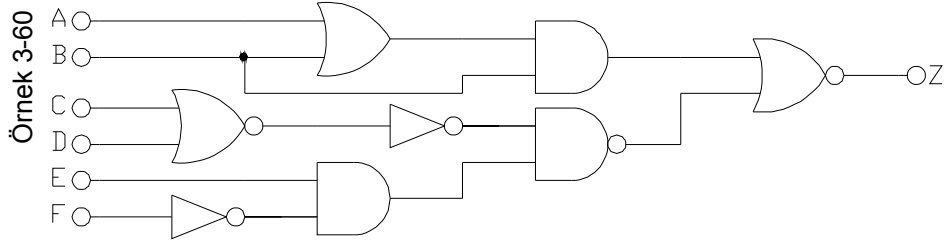
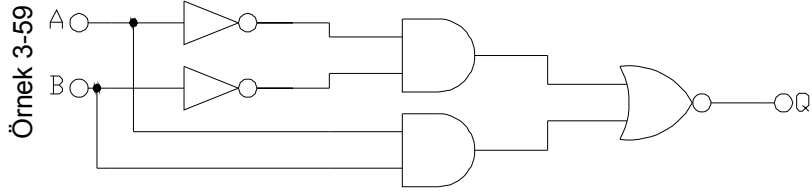

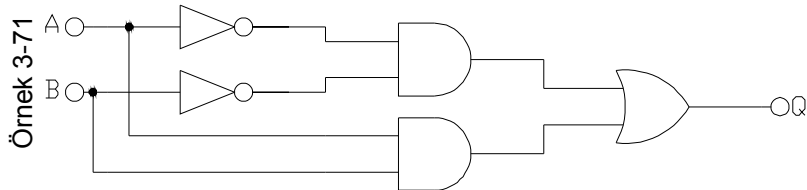
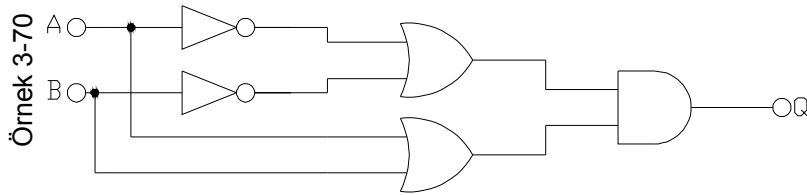
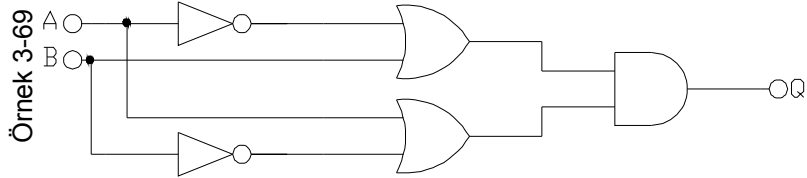
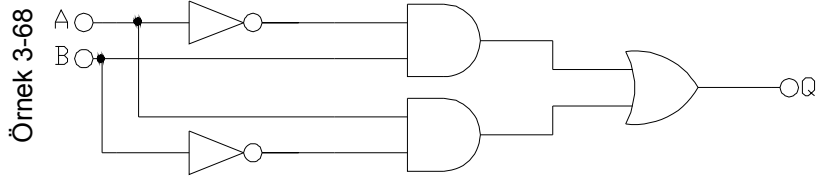
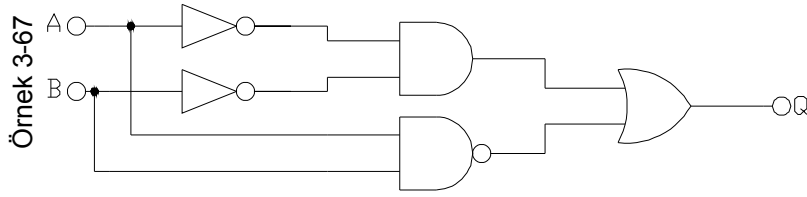
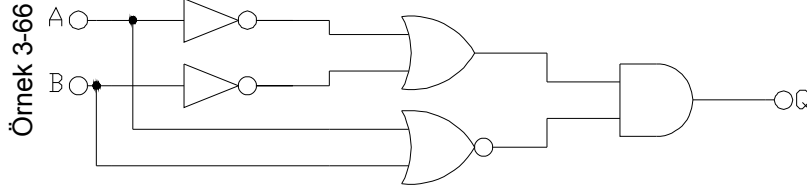
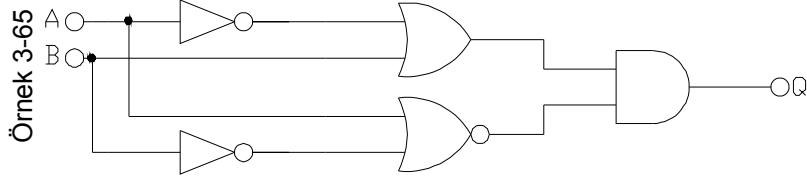

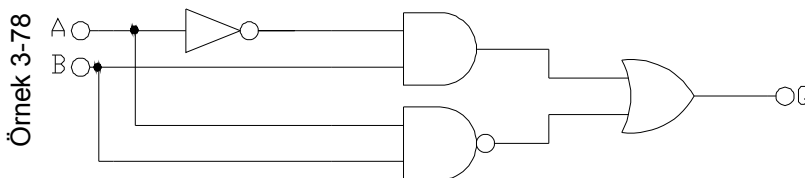
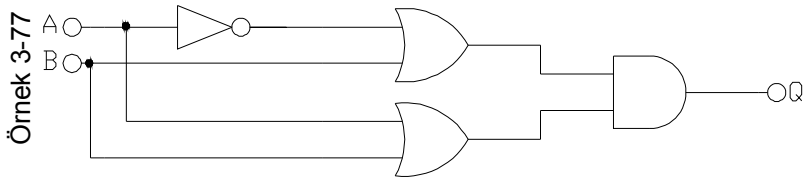
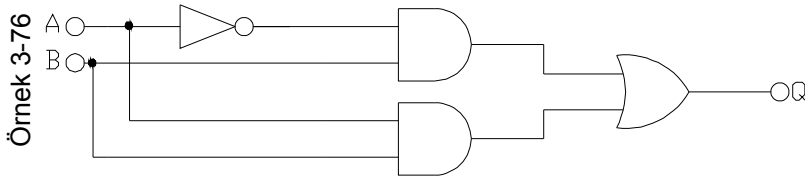
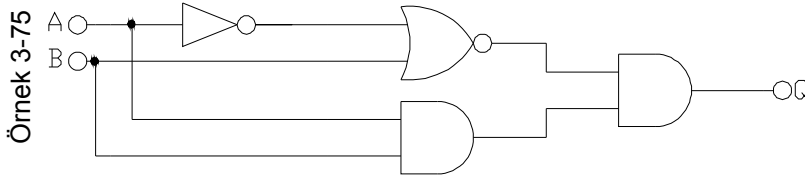
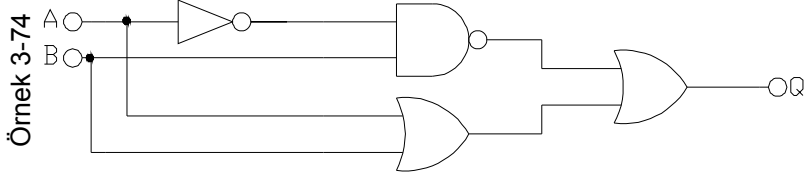
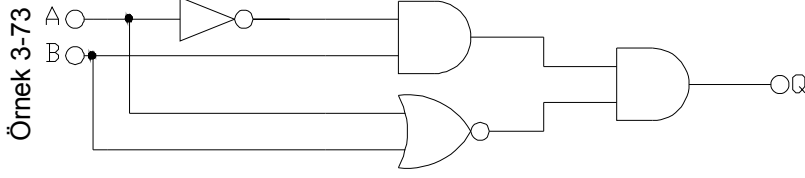
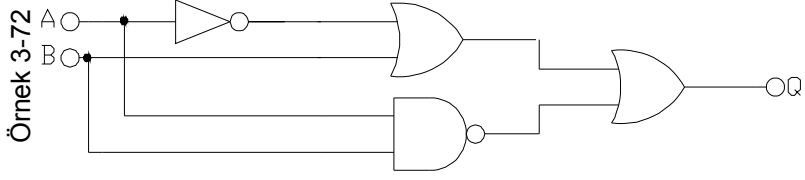

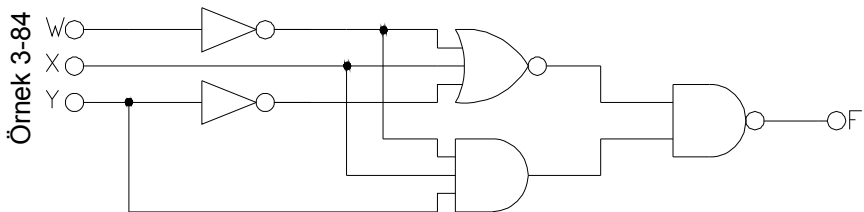
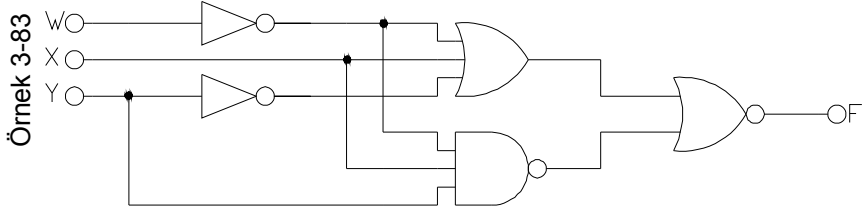
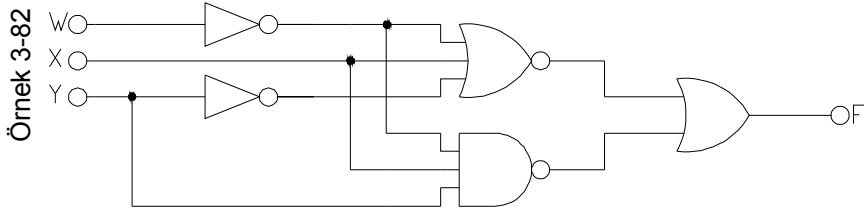
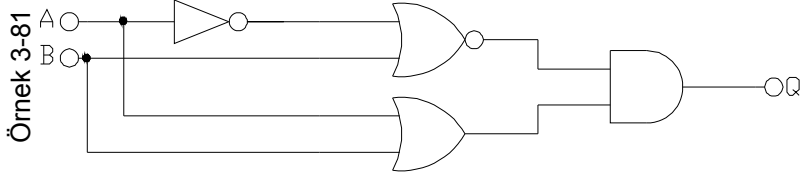
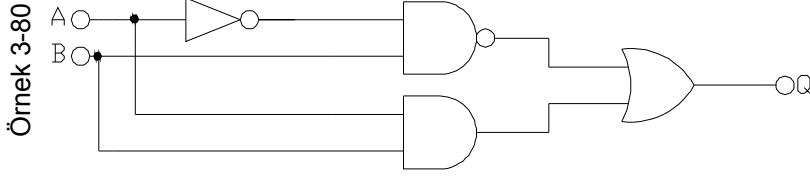
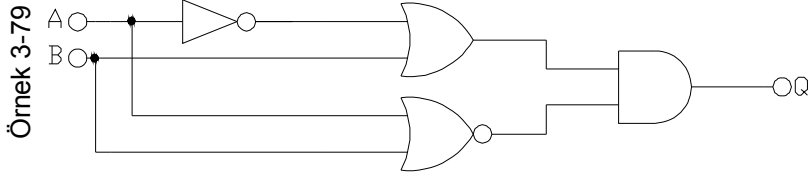

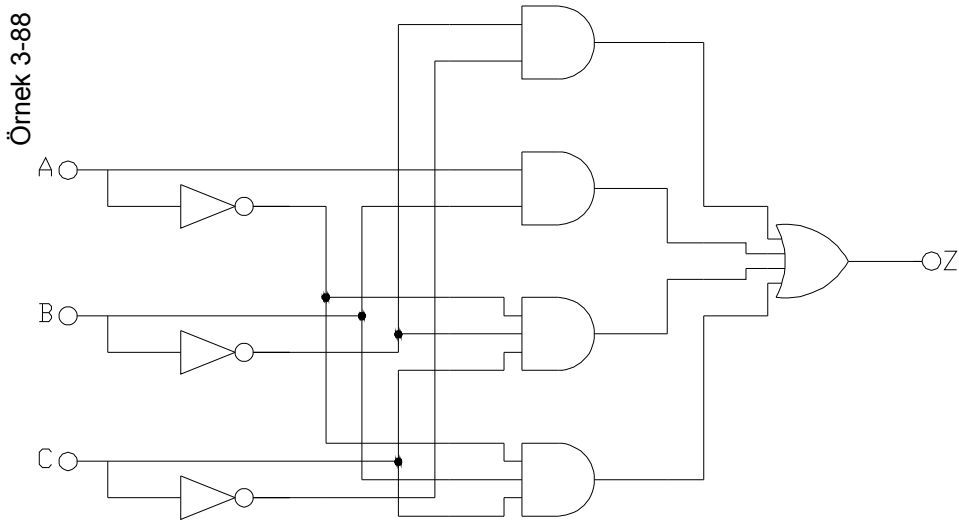
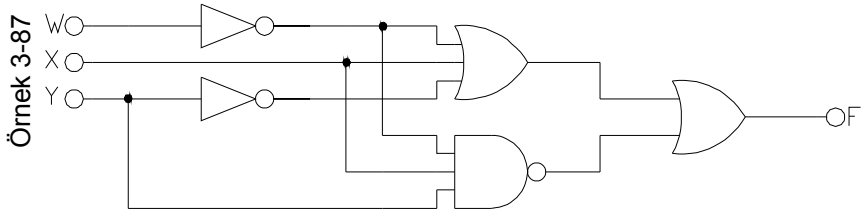
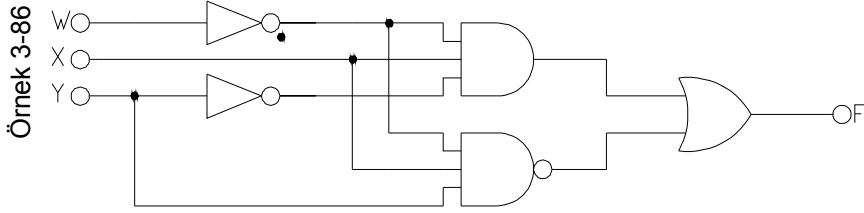
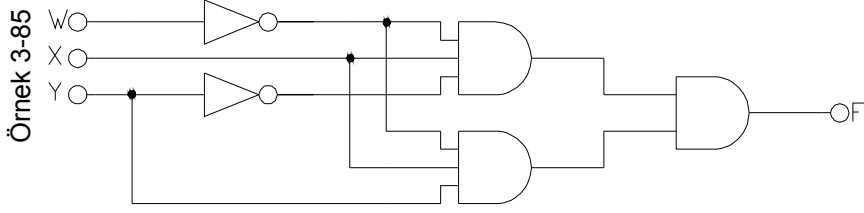

Örnek 3-89

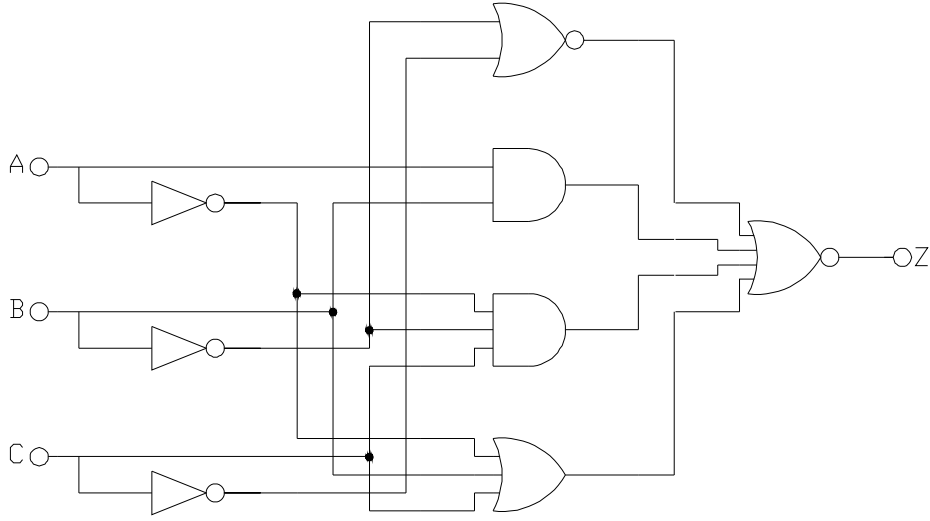

Örnek 3-90

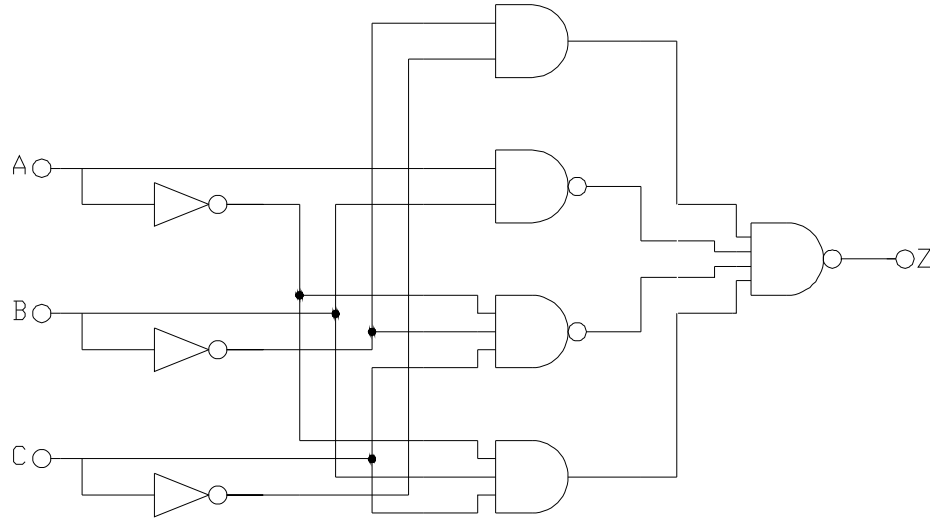

Örnek 3-91

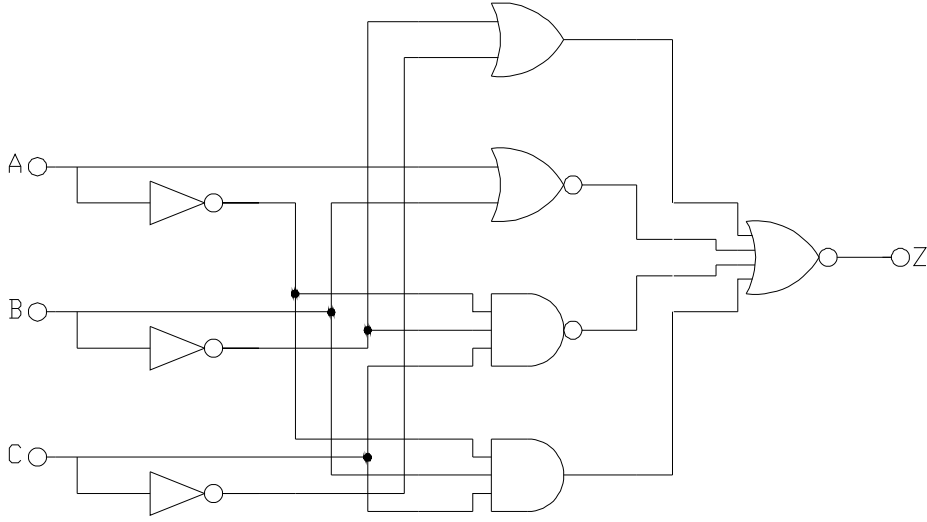

Örnek 3-92

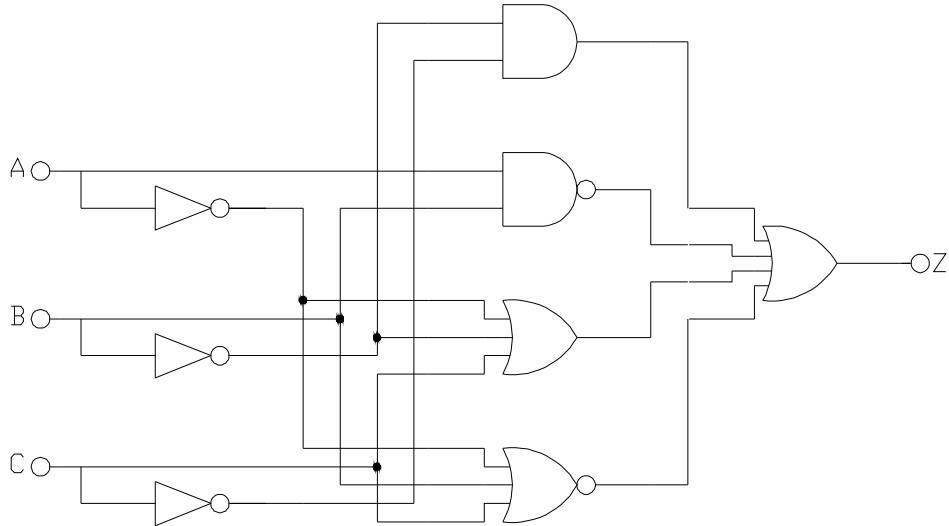

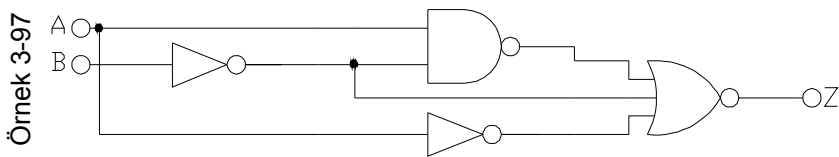
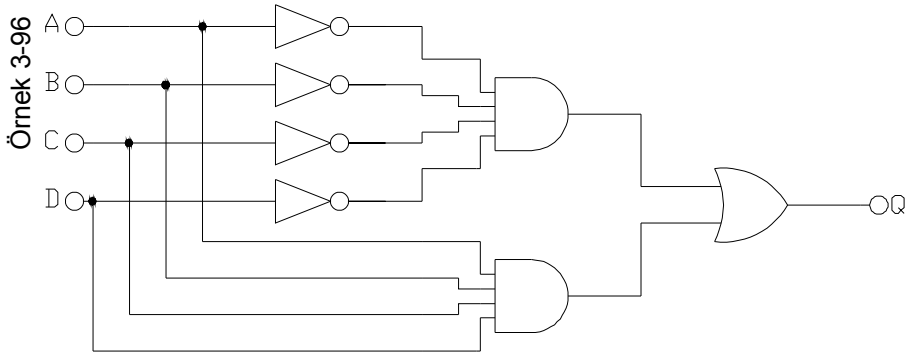
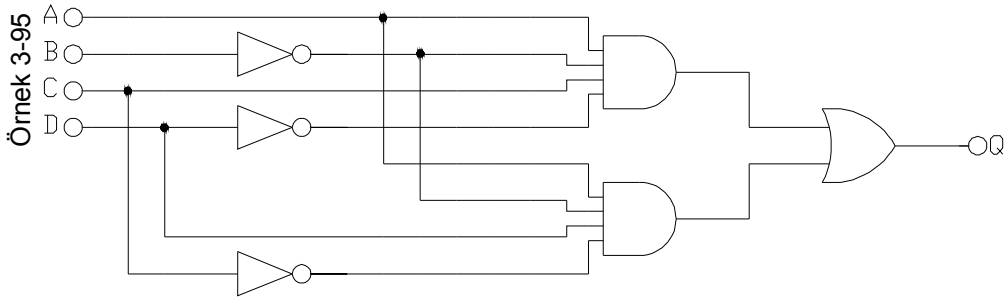
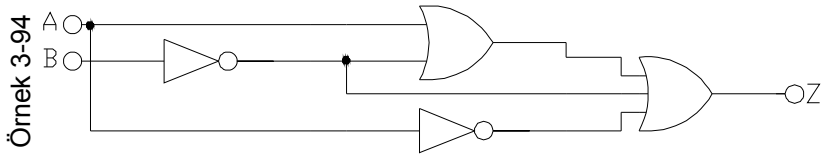
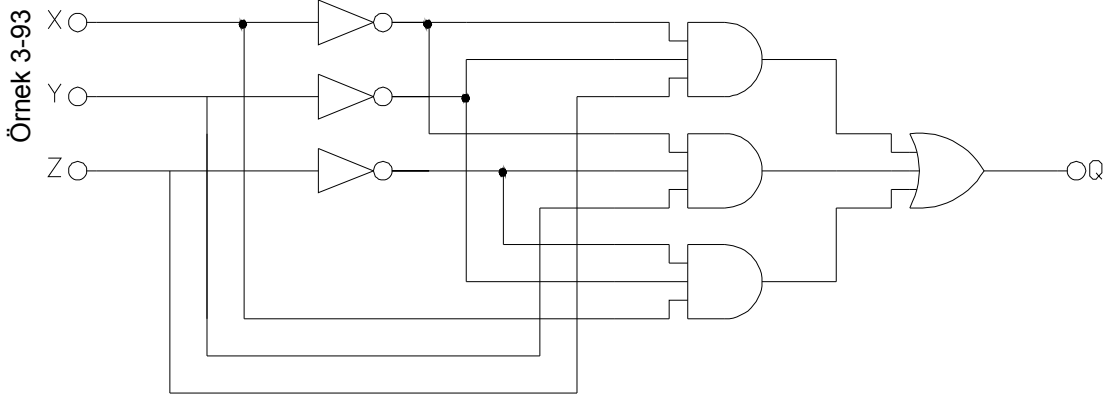

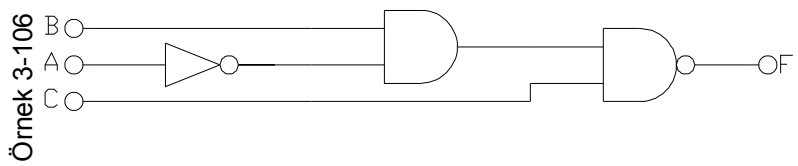
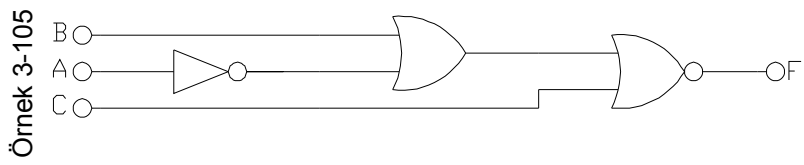
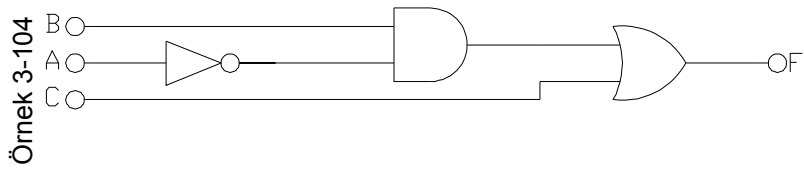
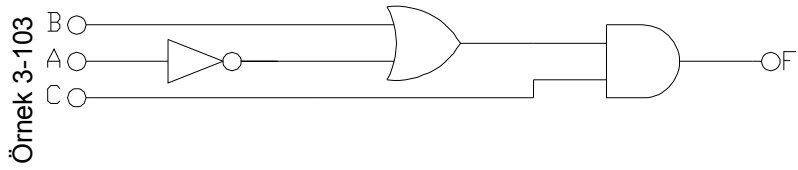
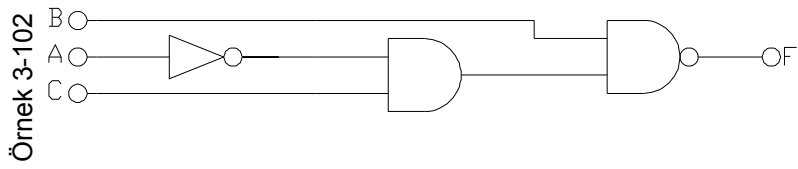
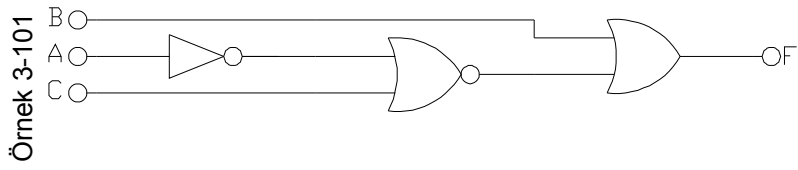
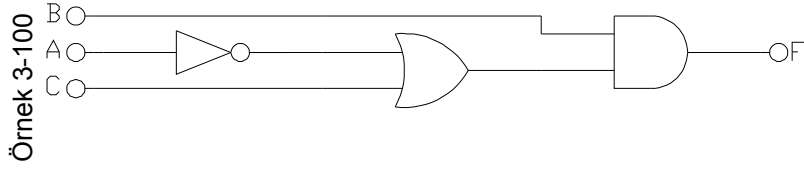
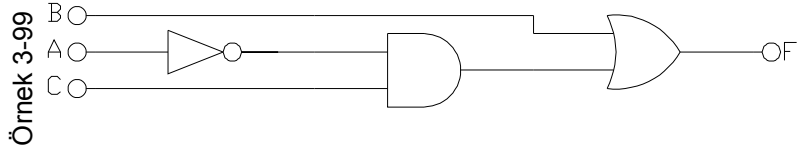
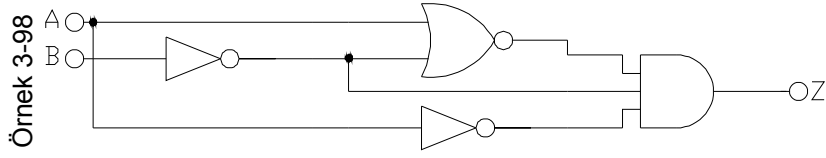

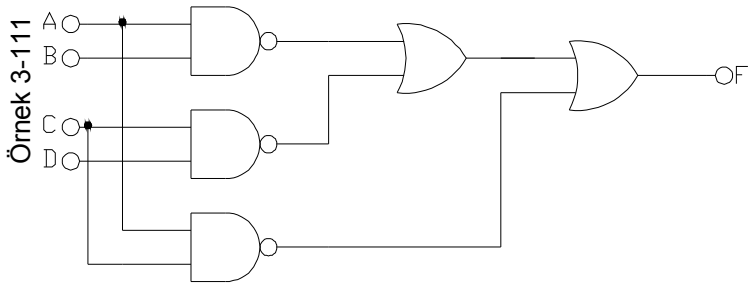
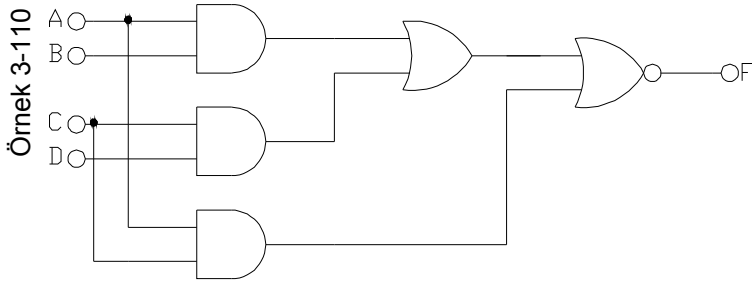
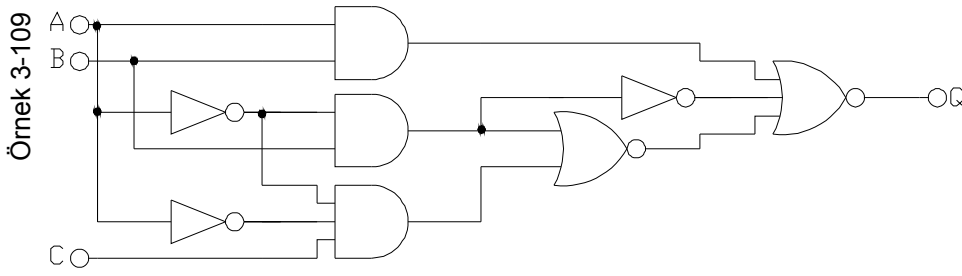
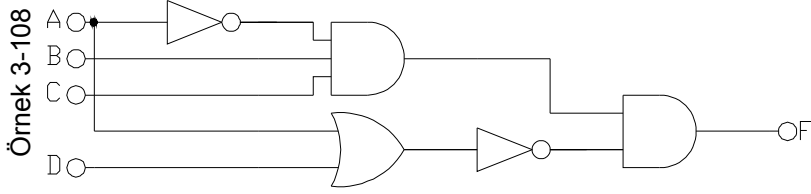
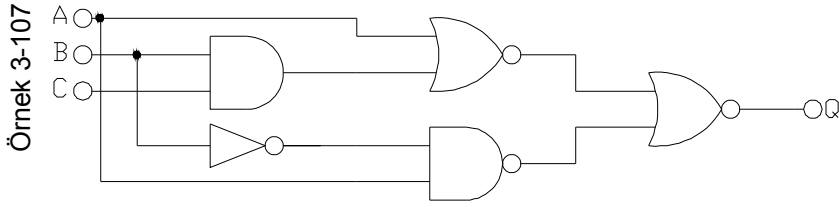

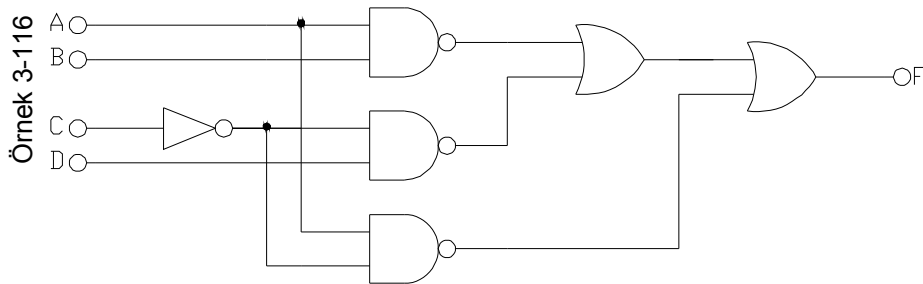
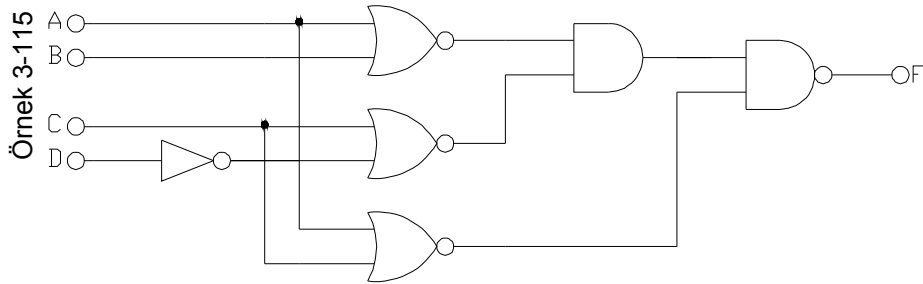
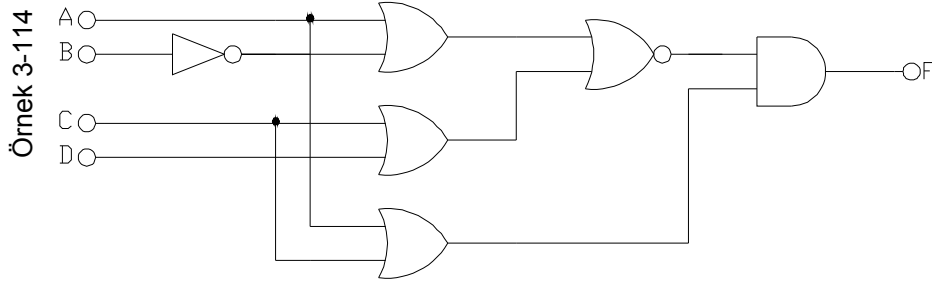
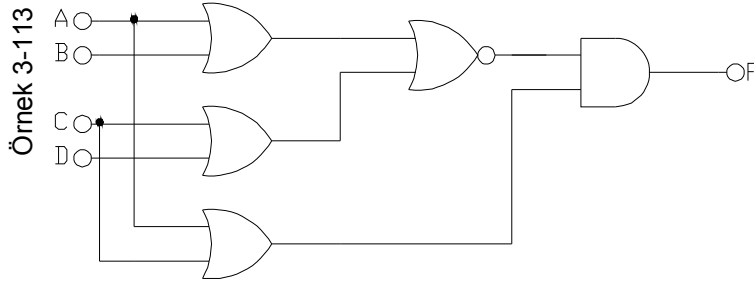
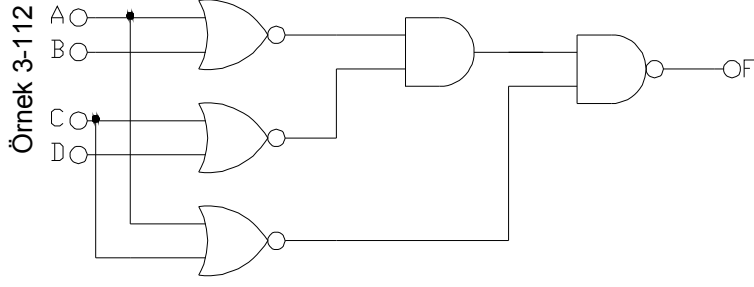

Örnek 3-117

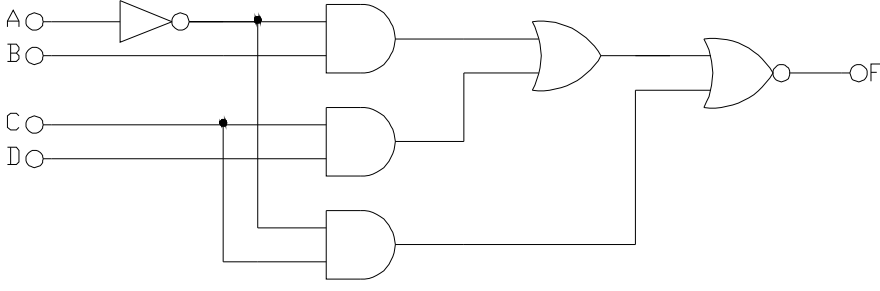

Örnek 3-118

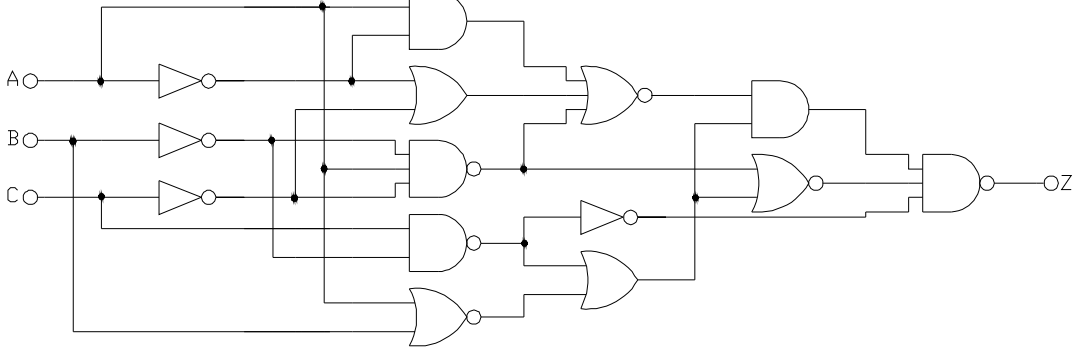

Örnek 3-119

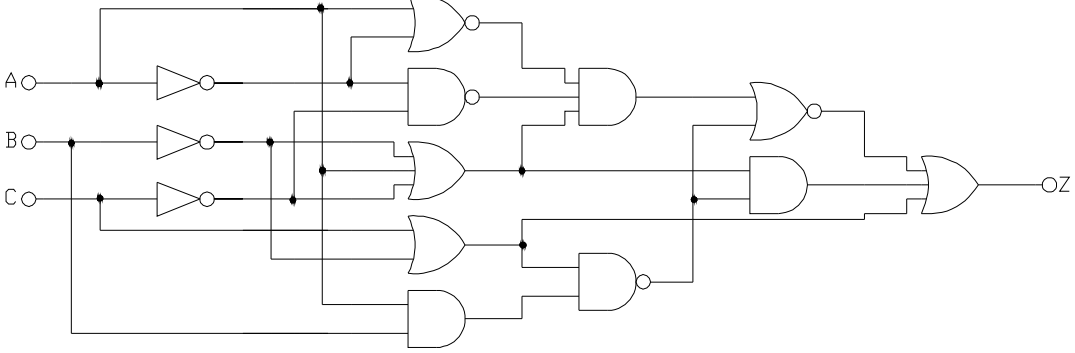

Örnek 3-120

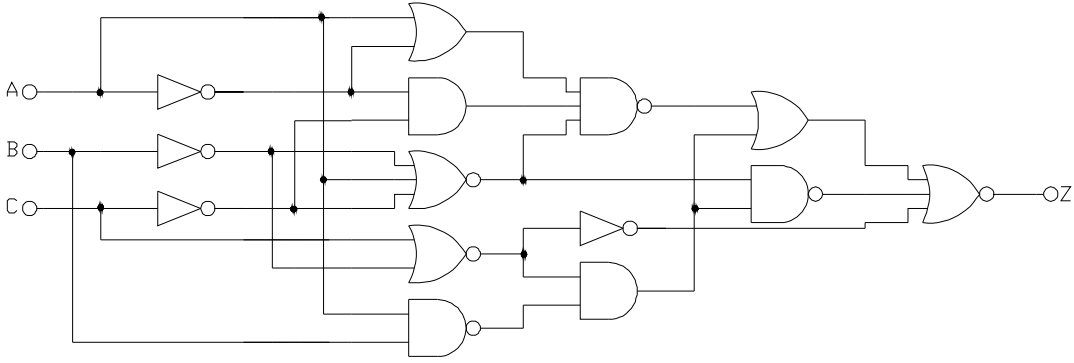

Örnek 3-121

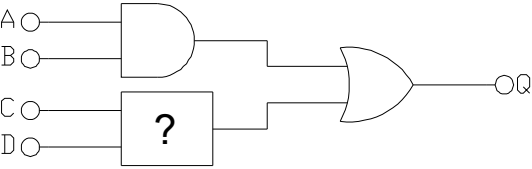

Yukarıda verilen lojik devrenin çıkışının $A \cdot B + (C \cdot D)^1$ olabilmesi için ? olan devre parçası ne olmalıdır

Örnek 3-122

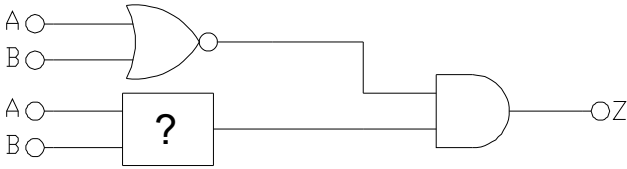

Yukarıda verilen lojik devrenin çıkışının $(A + B)^1 \cdot (C^1 + D)^1$ olabilmesi için ? olan devre parçası ne olmalıdır

Örnek 3-123

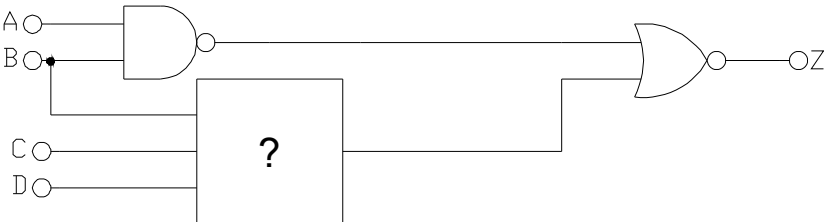

Cevap

Yukarıda verilen lojik devrenin çıkışının $[(C^1 + D) \cdot B^1 + (A \cdot B)^1]^1$ olabilmesi için ? olan devre parçası ne olmalıdır

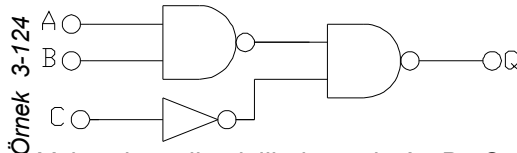

A	B	C	C'	A.B	(A.B)'	(A.B)'.C'	[(A.B)'+C']'
0	0	0	1	0	1	1	0
0	0	1	0	0	1	0	1
0	1	0	1	0	1	1	0
0	1	1	0	0	1	0	1
1	0	0	1	0	1	1	0
1	0	1	0	0	1	0	1
1	1	0	1	1	0	0	1
1	1	1	0	1	0	0	1

Yukarıda verilen lojik devrenin A , B , C girişlerine aşağıda grafiği verilen lojik sinyaller uygulandığında elde edilecek çıkış sinyalini çiziniz.

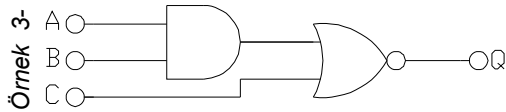
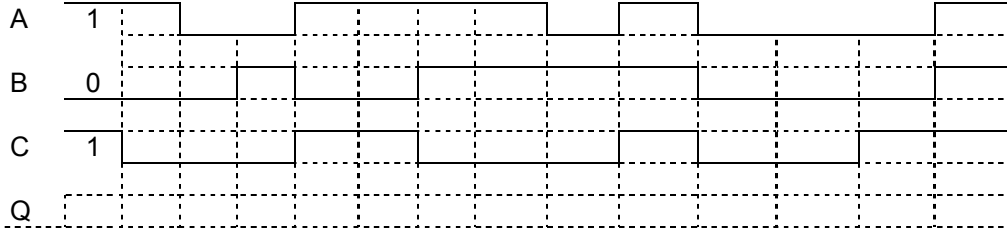

Yukarıda Ansi normunda verilmiş lojik devreyi Din normuna çeviriniz

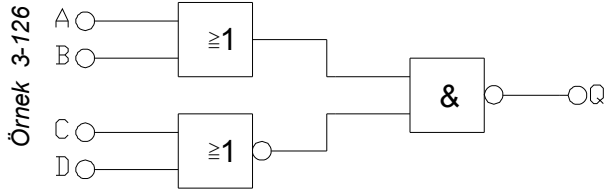

Yukarıda Din normunda verilmiş lojik devreyi Ansi normuna çeviriniz

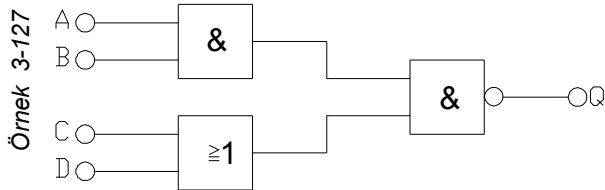

Yukarıda Din normunda verilen lojik devrenin çıkışından alınacak lojik ifadeyi bulunuz.

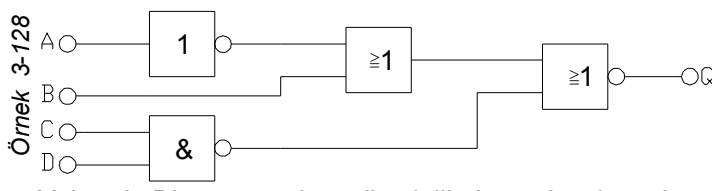

Yukarıda Din normunda verilen lojik devrenin çıkışından alınacak lojik ifadeyi bulunuz.

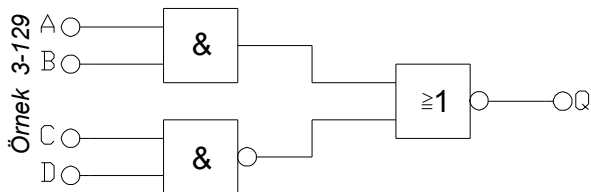

Yukarıda Din normunda verilen lojik devrenin çıkışından alınacak lojik ifadeyi bulunuz.

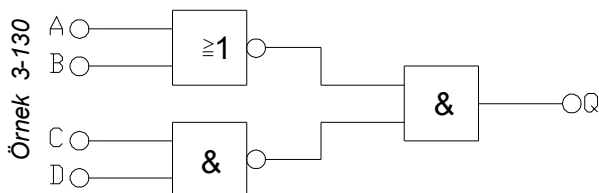

Yukarıda Din normunda verilen lojik devrenin çıkışından alınacak lojik ifadeyi bulunuz.

Örnek 3-131 $Q = A + C + A.B + C.D$ Lojik ifadesini Vedeğil kapıları ile oluşturunuz
 $Q = A + C + A.B + C.D \rightarrow Q = \overline{A} . \overline{C} . (\overline{A} . B) . (C . D)$